



# SPECIFICATION FOR LCD Module PV10108TD31F-C1

<b>MODULE:</b>	PV10108TD31F-C1
<b>CUSTOMER:</b>	

<b>TZD</b>	<b>INITIAL</b>	<b>DATE</b>
<b>PREPARED BY</b>	杨荣武	2019-11-1
<b>CHECKED BY</b>	陈志文	2019-11-1
<b>APPROVED BY</b>	罗教平	2019-11-1

<b>CUSTOMER</b>	<b>INITIAL</b>	<b>DATE</b>
<b>APPROVED BY</b>		



### REVISION STATUS

Version	Revise Date	Page	Content	Modified by
V1.0	2019-11-1	-	First Issued.	YANG



## TABLE OF CONTENTS

- 1.General Description
- 2. Electrical Characteristics
- 3. Pin Description
- 4. Electrical Characteristics
- 5. Optical Characteristics
- 6. Quality Specifications
- 7. Reliability
- 8. Handling Precaution
- 9. Package Drawing



## 1. General Description

### \* DESCRIPTION

PV10108TD31F-C1 is a color active matrix TFT (Thin Film Transistor) LCD (liquid crystal display) that uses amorphous silicon TFT as a switching device. This model is composed of a Transmissive type TFT-LCD Panel, driver circuit, back-light unit. The resolution of a 10.1" TFT-LCD contains 800\*1280 pixels, and can display up to 16.7M colors.

### \* Features

- Low Input Voltage: VDD: 3.3V
- Display Colors of TFT LCD: 16.7M colors
- CPU Interface: MIPI 4Lanes

General Information Items	Specification	Unit	Note
	Main Panel		
Display area(AA)	135.38(H) *216.576(V) (10.1inch )	mm	-
Driver element	a-Si TFT active matrix	-	-
Display colors	16.7M	colors	-
Number of pixels	800(RGB) *1280	dots	-
Pixel arrangement	RGB vertical stripe	-	-
Pixel pitch	0.1692(H) *0.1692(V)	mm	-
Viewing angle	ALL	o'clock	-
Drive IC	OTM1287A	-	-
Display mode	Normally BLACK	-	-
Operating temperature	0~+50	°C	-
Storage temperature	-10~+60	°C	-

### Mechanical Information

Item		Min.	Typ.	Max.	Unit	Note
Module size	Horizontal(H)	-	154.56	-	mm	±0.07
	Vertical(V)	-	253.06	-	mm	±0.07
	Depth(D)	-	4.17	-	mm	±0.25
Weight		-	TBD	-	g	-



## 2. Mechanical Specification

保存期限: 三年

版本号: A/1

表格受控编号:

### 一. LCM产品特征 (LCM Features):

显示类型 (Display mode):	TFT/Normal BLACK
驱动芯片 (Driver IC):	OTM1287A
人眼观察角 (Viewing Direction):	ALL
接口类型 (Interface Types):	MIPI VIDDED MODE
背光类型 (Backlight Type):	29res. 8串0.9mm(22.5mm/L)LED, 电压为22.4V-27.2V
LCD对比度 (LCD Contrast):	300 cd/m <sup>2</sup> Min, 330 cd/m <sup>2</sup> TYP
颜色坐标 (Color Coordinate):	(X:0.31±0.03, Y:0.33±0.03)
模组均匀度 (LCD Uniformity):	80% MIN
操作温度 (Operating Temperature):	-0 °C ~ 50 °C
储存温度 (Storage Temperature):	-10 °C ~ 60 °C
平面弯曲度 (Plane Warpage Index):	<0.1MM
连接器 (IPC CONNOR):	XYT-ZF20-31F-00

### 二. CTP技术要求 (CTP Technical requirements)

- 材料类型: GFF, 最大厚度 85 μm; 1. 制程类型: GFF, 最大厚度 85 μm; 1.2C电压: 1.8V
- 制程: 11L2511(二程)
- 材料: 玻璃厚度 1.1mm; 玻璃厚度 1.1mm; 玻璃厚度 1.1mm; 玻璃厚度 1.1mm
- 制程: 100μm; 制程: 100μm; 制程: 100μm; 制程: 100μm
- 制程: 100μm; 制程: 100μm; 制程: 100μm; 制程: 100μm
- 制程: 100μm; 制程: 100μm; 制程: 100μm; 制程: 100μm
- 制程: 100μm; 制程: 100μm; 制程: 100μm; 制程: 100μm
- 制程: 100μm; 制程: 100μm; 制程: 100μm; 制程: 100μm
- 制程: 100μm; 制程: 100μm; 制程: 100μm; 制程: 100μm
- 制程: 100μm; 制程: 100μm; 制程: 100μm; 制程: 100μm

### LED CIRCUIT DIAGRAM

Vf=22.4V-26.4V (If=422.5-500mA)

生产日期: \_\_\_\_\_

物料名称: PTV10108TD31F-C1

物料编号: PTV10108TD31F-C1

日期: 19/02/19

变更记录 (Change History):

版本 (Version)	序号 (Serial)	变更内容 (Change)	日期 (Date)
V4			
V3			
V2			
V1			
V0			



### 3. PIN DESCRIPTION

LCM

Pin NO.	Symbol	Function
1	GND	Ground
2	LEDK	Backlight-
3	LEDA	Backlight+
4	GND	Ground
5	NC	Not Connect
6	VBAT	Power supply 2.8V~3.3V
7	GND	Ground
8	NC	Not Connect
9	GND	Ground
10	D3N	DSI_D3N are differential data signal line
11	D3P	DSI_D3P are differential data signal line
12	GND	Ground
13	D0N	DSI_D0N are differential data signal line
14	D0P	DSI_D0P are differential data signal line
15	GND	Ground
16	CLKN	DSI_CLKN are differential data signal line
17	CLKP	DSI_CLKP are differential data signal line
18	GND	Ground
19	D1N	DSI_D1N are differential data signal line
20	D1P	DSI_D1P are differential data signal line
21	GND	Ground
22	D2N	DSI_D2N are differential data signal line
23	D2P	DSI_D2P are differential data signal line
24	GND	Ground
25	RESET	Hardware reset pin
26	TE	Tearing effect output
27	NC	Not Connect
28	GND	Ground
29	LCD-ID (电源使能端)	Power supply 2.8V~3.3V
30	NC	Not Connect
31	GND	Ground



## CTP

1	NC	Not Connect
2-3	GND	Ground
4	SCL	Serial clock input
5	SDA	Serial data input pin
6	VDD2.8	Power supply 2.8V
7	INT	Interrupt pin
8	REST	Hardware reset pin
9	NC	Not Connect
10-11	GND	Ground
12-13	NC	Not Connect





## 4. ELECTRICAL CHARACTERISTICS

### 4.1 ABSOLUTE MAXIMUM RATINGS

Item	Symbol	Values		Unit	Remark
		Min	Max.		
Supply Voltage for Logic circuit	VDD	3.0	3.6	V	VDD=150mA
Supply Voltage for analog circuit	IOVDD	1.65	3.3	V	IOVDD=30mA

### 4.2 DC ELECTRICAL CHARACTERISTICS

#### 4.2.1 OPERATING CONDITIONS

Typical Operating Conditions (Ta=25°C)

Item	Symbol	Values			Unit	Remark
		Min	Typ	Max.		
Digital Supply Voltage	Vdd	3	3.3	3.6	V	
Analog Supply Voltage	AVDD	9.4	9.6	10	V	
Common Voltage	VCOM	3.2	3.4	3.6	V	
TFT Gate ON Voltage	VGH	-	15	-	V	
TFT Gate OFF Voltage	VGL	-	-13	-	V	

#### 4.2.2 BACKLIGHT UNIT (GND=0V)

Item	Symbol	Values			Unit	Remark
		Min	Typ	Max.		
Forward supply Voltage	V <sub>f</sub>	22.4	25.6	27.2	V	
Forward supply Current	I <sub>f</sub>	-	90	-	mA	
LCM Luminance	L <sub>v</sub>	300	330	-	cd/m <sup>2</sup>	I <sub>B</sub> =90mA
Uniformity	/	80			%	-





### 4.3 TIMING CHARACTERISTICS

#### 3.6 power on/off sequence

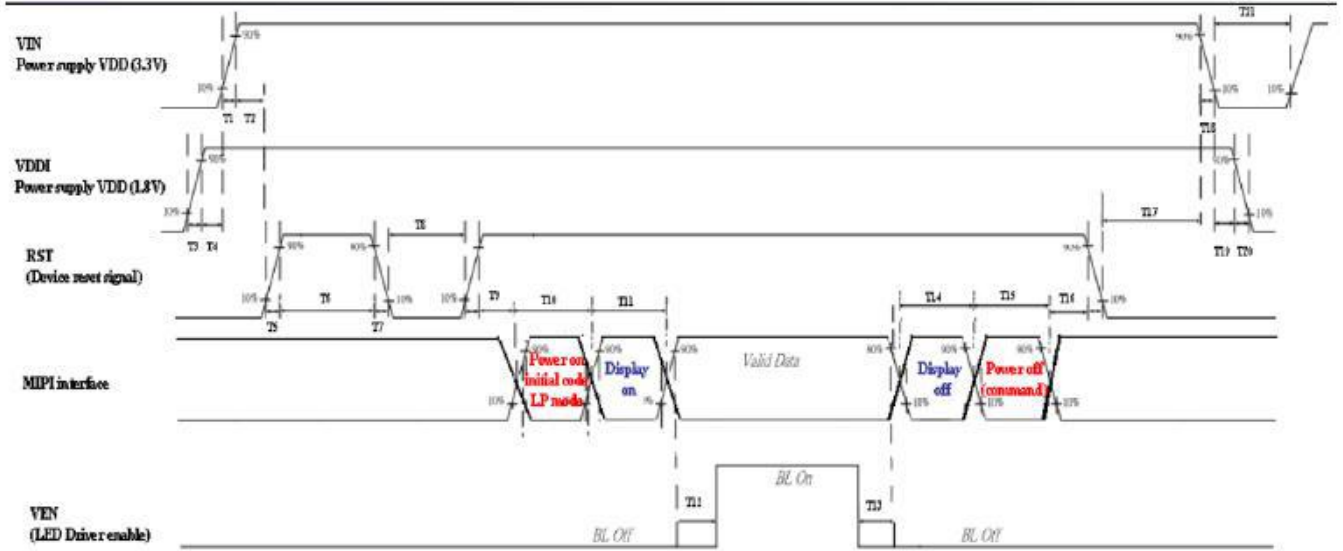



<b>Power Sequence Timing</b>			
<b>Parameter</b>	<b>Value</b>		<b>Units</b>
	<b>Min.</b>	<b>Max.</b>	
<b>T1</b>	<b>0.5</b>	<b>10</b>	<b>ms</b>
<b>T2</b>	<b>1</b>	<b>-</b>	
<b>T3</b>	<b>0.5</b>	<b>10</b>	
<b>T4</b>	<b>0</b>	<b>50</b>	
<b>T5</b>	<b>0</b>	<b>0.002</b>	
<b>T6</b>	<b>5</b>	<b>-</b>	
<b>T7</b>	<b>0</b>	<b>0.002</b>	
<b>T8</b>	<b>0.1</b>	<b>-</b>	
<b>T9</b>	<b>10</b>	<b>-</b>	
<b>T10</b>	<b>180</b>	<b>-</b>	
<b>T11</b>	<b>60</b>	<b>-</b>	
<b>T12</b>	<b>200</b>	<b>-</b>	
<b>T13</b>	<b>200</b>	<b>-</b>	
<b>T14</b>	<b>33.4</b>	<b>-</b>	
<b>T15</b>	<b>180</b>	<b>-</b>	
<b>T16</b>	<b>50</b>	<b>-</b>	
<b>T17</b>	<b>120</b>	<b>-</b>	
<b>T18</b>	<b>0</b>	<b>10</b>	
<b>T19</b>	<b>0</b>	<b>10</b>	
<b>T20</b>	<b>0</b>	<b>10</b>	
<b>T21</b>	<b>500</b>	<b>-</b>	



### 3.8 Timing

Vertical Total	VT (tv)	<b>1300</b>	line
Vertical Front-Porch	VFP (tvp)	<b>8</b>	line
Vertical Active	VA (tvd)	<b>1280</b>	line
Vertical Sync.	VS (twv)	<b>4</b>	line
Vertical Back-Porch	VBP (tvp)	<b>8</b>	line
Horizontal Total	HT (th)	<b>960</b>	clk(pixel)
Horizontal Front-Porch	HFP (thfp)	<b>24</b>	clk(pixel)
Horizontal Active	HA (thd)	<b>800</b>	clk(pixel)
Horizontal Sync.	HS (thw)	<b>4</b>	clk(pixel)
Horizontal Back-Porch	HBP (thbp)	<b>132</b>	clk(pixel)
Pixel Frequency	CLK (fc)	<b>75.00</b>	MHz



## Driving

(LVDS Receiver Output)

### Vertical Timing

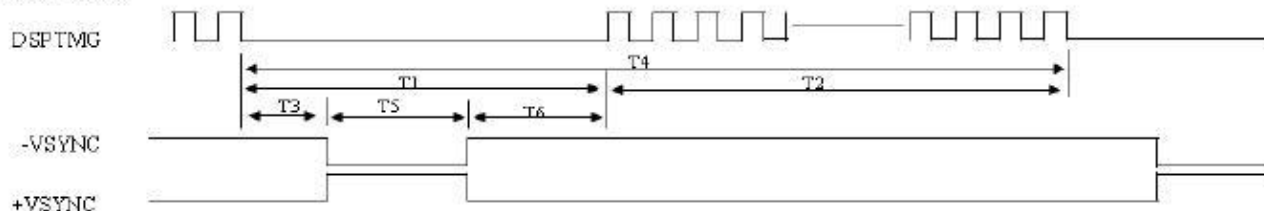

Item	T1 Vertical Blanking	T2 Active Field	T3 VSYNC Front Porch	T4 Frame Time	T5 VSYNC Width	T6 VSYNC Back Porch
Value	20	1280	8	1300	4	8

### Horizontal Timing

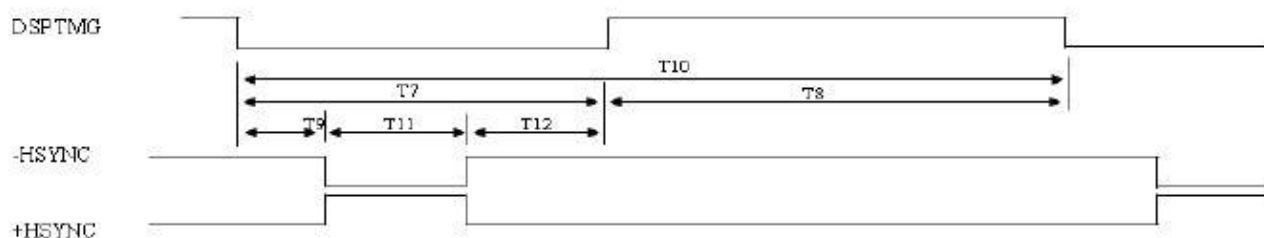

Item	T7 Horizontal Blanking	T8 Active Field	T9 HSYNC Front Porch	T10 H Line Time	T11 HSYNC Width	T12 HSYNC Back Porch
Value	160	800	24	960	4	132

### Dot Timing

Item	Dot Clock Frequency	Data Clock Frequency
Value	75MHz	Dot Clock Frequency





## 5.OPTICAL CHARACTERISTICS

5. The following items are measured under stable conditions. The optical characteristics should be measured in a dark room or equivalent state with the methods shown in Note.0.

Item	Symbol	Conditions	Min.	Typ.	Max.	Unit	Note
Viewing Angle	$\theta_R$ $\theta_L$	Horizontal (Right) CR = 10 (Left)	80	85	-	degree	1, 6
			80	85	-		
	$\psi_H$ $\psi_L$	Vertical (Upper) CR = 10 (Lower)	80	85	-		
			80	85	-		
Contrast Ratio	CR		800	1000	-		1, 3
Cross talk	%		---	---	4		1, 4
Response Time	$T_{RT}$	Rising + Falling	-	30	35	msec	5
Color / Chromaticity Coordinates	Red	Rx	CIE 1931	0.580	0.610	0.640	@Silicate LED BL 模 擬值
		Ry		0.318	0.348	0.378	
	Green	Gx		0.310	0.340	0.370	
		Gy		0.569	0.599	0.629	
	Blue	Bx		0.122	0.152	0.182	
		By		0.055	0.085	0.115	
	White	Wx		0.270	0.300	0.330	
		Wy		0.290	0.320	0.350	
NTSC	%	-	-	58	-		
Transmittance	%		5.1	5.8	NA		

Note.1: Definition of Viewing Angle: Refer to figure as below:

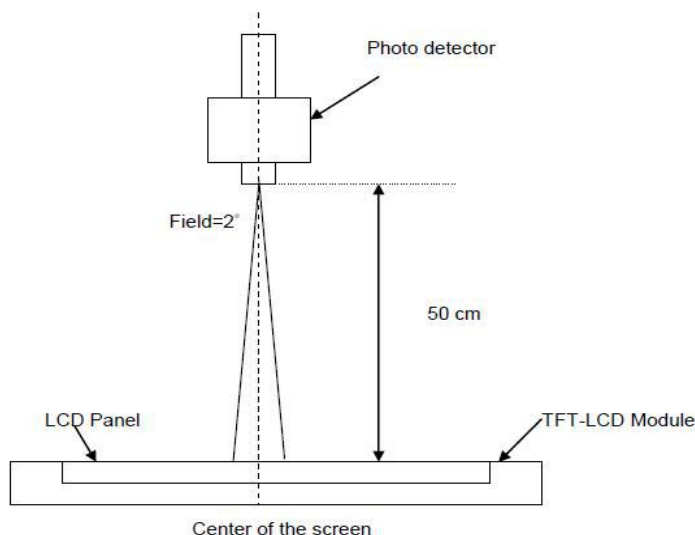



**Note 2 :** Definition of Average Luminance of White ( $Y_L$ ):

Measure the luminance of gray level 63 at 5 points ·  $Y_L = [L(1) + L(2) + L(3) + L(4) + L(5)] / 5$   
 $L(x)$  is corresponding to the luminance of the point X at Figure in Note (1).

**Note 3 :** Definition of contrast ratio:

Contrast ratio is calculated with the following formula.

$$\text{Contrast ratio (CR)} = \frac{\text{Brightness on the "White" state}}{\text{Brightness on the "Black" state}}$$

**Note 4 :** Definition of Cross Talk (CT)

$$CT = |Y_B - Y_A| / Y_A \times 100 (\%)$$

Where

$Y_A$  = Luminance of measured location without gray level 0 pattern (cd/m<sup>2</sup>)

$Y_B$  = Luminance of measured location with gray level 0 pattern (cd/m<sup>2</sup>)

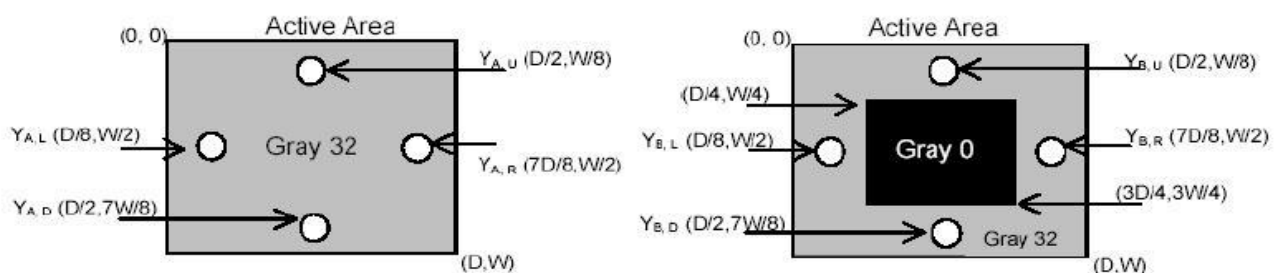

**Note 5:** Definition of response time:

The output signals of BM-7 or equivalent are measured when the input signals are changed from "Black" to "White" (falling time) and from "White" to "Black" (rising time), respectively. The response time interval between the 10% and 90% of amplitudes. Refer to figure as below.

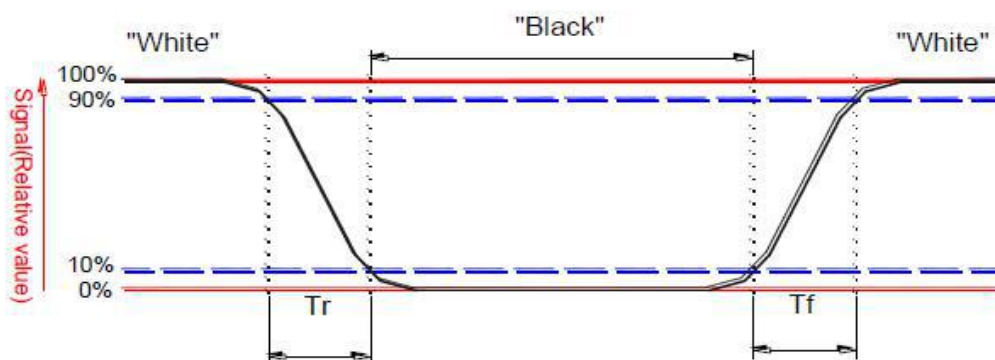



**Note 6.** Definition of viewing angle

Viewing angle is the measurement of contrast ratio  $\geq 10$ , at the screen center, over a 180° horizontal and 180° vertical range (off-normal viewing angles). The 180° viewing angle range is broken down as follows; 90° ( $\theta$ ) horizontal left and right and 90° ( $\Phi$ ) vertical, high (up) and low (down). The measurement direction is typically perpendicular to the display surface with the screen rotated about its center to develop the desired measurement viewing angle.

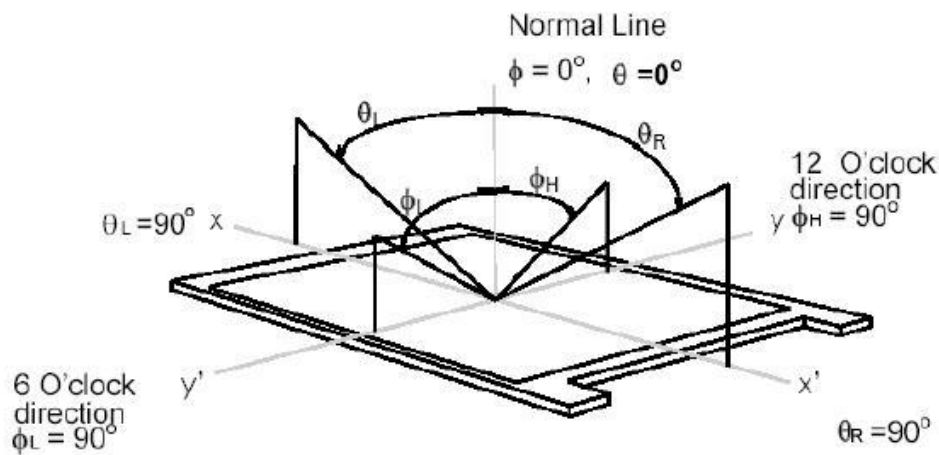





## 6. QUALITY SPECIFICATIONS

### 1. Inspection condition

1.1:Cosmetic inspection: viewing distance is about 30cm with bare eyes, and under an environment of 20~40W light intensity ( 600~1200LUX ) , all directions for inspecting the sample should be within 45° against perpendicular line.

6.1.2:Function inspection: viewing distance is about 30cm with bare eyes, and under an environment of 300LUX light intensity, all directions for inspecting the sample should be within 45° against perpendicular line.

### 2. Definition of Inspection Item.

2.1 Definition of Inspection zone in I-touch module.

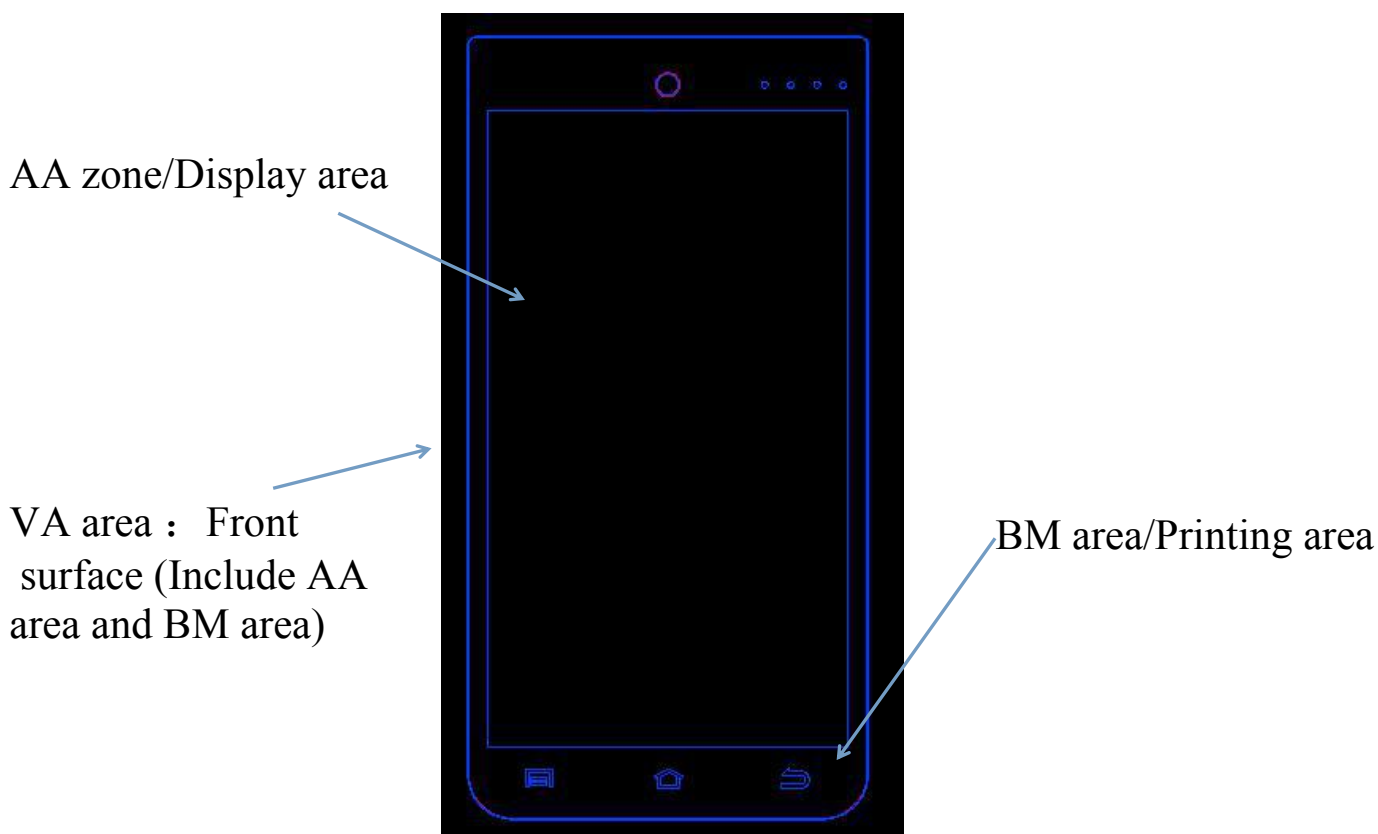

AA zone: Character/Display area

BM zone: Printing area

VA zone: Viewing area ( AA area + BM area = viewing area )

### 3. Defect definition



3.1 Circular defect

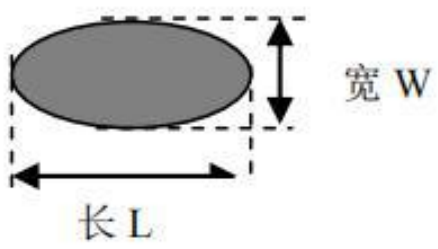

Diameter  $\Phi = 1/2(L+W)$

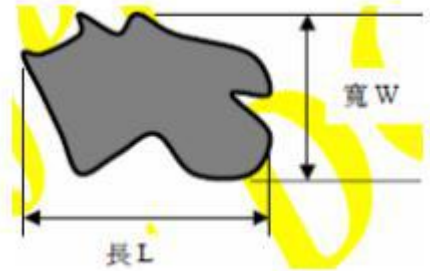

Diameter  $\Phi = 1/2(L+W)$

3.2 Linear defect

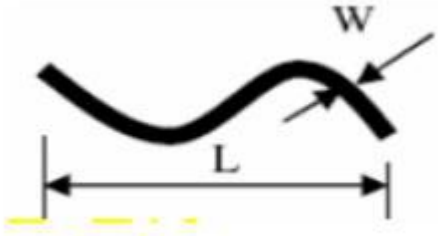

3.3 Pin hole

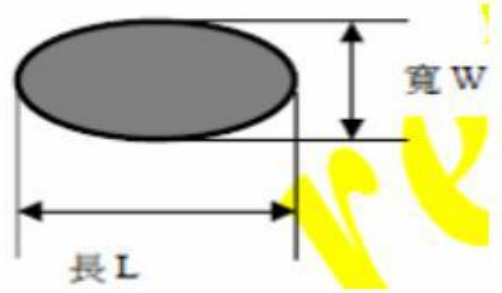
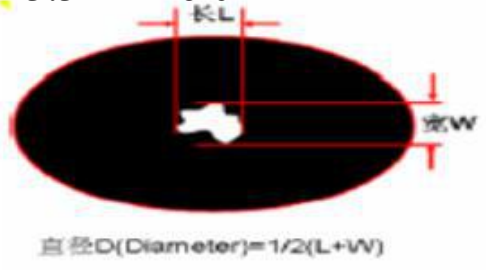

3.4 Zigzag

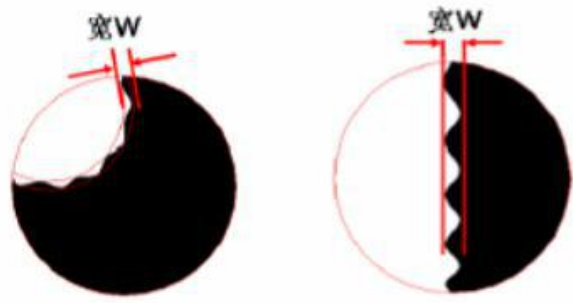

4. Inspection

standards

4.1 Major defect

-Item -No	Items to be inspected	Inspection Standard	Classification of defects
-----------	-----------------------	---------------------	---------------------------



4.1.1	All functional defects	1) No display 2) Display abnormally 3) Missing vertical, horizontal segment 4) Short circuit 5) Back-light no lighting, flickering and abnormal lighting. 6) Touch panel abnormal.	Major
4.1.2	Missing	Missing component	
4.1.3	Outline dimension	Overall outline dimension beyond the drawing is not allowed.	
4.1.4	LCD Mura	LCD Mura according to ND 5% keep out to determine, if keep out distance at 30cm be seen by eyes is NG, otherwise will be ok if invisible.	

## 4.2 Cosmetic defect

Item No	Items to be inspected	Inspection Standard		Classification of defects
4.2.1	Dot defect	Zone Size(mm)	VA area	Minor
			Acceptable Qty	
		$\Phi \leq 0.1$	Ignore	
		$0.10 < \Phi \leq 0.25$	3	
		$0.25 < \Phi \leq 0.30$	1	
$0.30 < \Phi$	0			
4.2.2	Dim Spots: Circle shaped and dim edged defects	Zone Size(mm)	VA area	Minor
			Acceptable Qty	
		$\Phi \leq 0.20$	Ignore	
		$0.20 < \Phi \leq 0.40$	3	
		$0.40 < \Phi \leq 0.60$	2	
$0.60 < \Phi$	0			
Item No	Items to be inspected	Inspection Standard		Classification of defects





4.2.3	Dent Spot Fish eye	Zone		VA area	Minor
		Size(mm)		Acceptable Qty	
		$\Phi \leq 0.10$		Ignore	
		$0.10 < \Phi \leq 0.20$		3	
		$0.20 < \Phi \leq 0.30$		2	
$0.30 < \Phi$		0			
4.2.4	Line defect	Zone		VA area	Minor
		Size(mm)		Acceptable Qty	
		L ( Length )	W ( Width )	Acceptable Qty	
		Ignore	$W \leq 0.03$	Ignore	
		$L \leq 5.0$	$0.03 < W \leq 0.05$	3	
		$L \leq 3.0$	$0.05 < W \leq 0.07$	1	
/	$0.07 < W$	Define as spot defect			
4.2.5	Scratch	<p>If the scratch can be seen after mobile phone cover assembling or in the operating condition, judged as the line defect of 4.2.4.</p> <p>If the scratch can be seen only in non-operating condition or some special angle, judged as the following table.</p>			Minor
		Size (mm)		VA area	
		L ( Length )	Acceptable Qty	Acceptable Qty	
		Ignore	$W \leq 0.03$	Ignore	
		$5.0 < L \leq 10.0$	$0.03 < W \leq 0.05$	2	
		$L \leq 5.0$	$0.05 < W \leq 0.08$	1	
		/	$W > 0.08$	0	



Item No	Items to be inspected	Inspection Standard	Classification of defect										
4.2.6	Bubble	<table border="1"> <thead> <tr> <th>Zone</th> <th>VA area</th> </tr> <tr> <th>Size(mm)</th> <th>Acceptable Qty</th> </tr> </thead> <tbody> <tr> <td><math>\Phi \leq 0.15</math></td> <td>Ignore</td> </tr> <tr> <td><math>0.15 &lt; \Phi \leq 0.25</math></td> <td>2</td> </tr> <tr> <td><math>0.25 &lt; \Phi</math></td> <td>0</td> </tr> </tbody> </table>	Zone	VA area	Size(mm)	Acceptable Qty	$\Phi \leq 0.15$	Ignore	$0.15 < \Phi \leq 0.25$	2	$0.25 < \Phi$	0	Minor
Zone	VA area												
Size(mm)	Acceptable Qty												
$\Phi \leq 0.15$	Ignore												
$0.15 < \Phi \leq 0.25$	2												
$0.25 < \Phi$	0												
4.2.7	Glass defect	<p>4.2.7a Chip on corner or surface</p> <table border="1"> <thead> <tr> <th>L(length)</th> <th>W(width)</th> <th>Z(thickness)</th> </tr> </thead> <tbody> <tr> <td><math>L \leq 0.30</math></td> <td><math>W \leq 0.20</math></td> <td>T/2</td> </tr> </tbody> </table> <p>Notes: T=Lens thickness, <math>\Phi \leq 0.10</math> ignore Acceptable Qty: Single edge <math>N \leq 2</math>, Total <math>N \leq 4</math></p> <p>4.2.7b Cracks Cracks tend to break are not allowed.</p>	L(length)	W(width)	Z(thickness)	$L \leq 0.30$	$W \leq 0.20$	T/2					
L(length)	W(width)	Z(thickness)											
$L \leq 0.30$	$W \leq 0.20$	T/2											

Item	Items to be	Inspection Standard	Classification
------	-------------	---------------------	----------------



No	inspected		of defect
4.2.8	Parts alignment	1) Not allow IC and FPC/heat-seal lead width is more than 50% beyond lead pattern. 2) Not allow chip or solder component is off center more than 50% of the pad outline.	Minor
4.2.9 view area/ printing area of front surface and view area of rear surface	LOGO Pattern	 <p><b>Dot: according to Dot spec.</b>  <b>Thickness odds:</b></p> $\frac{  \text{Spec pattern width} - \text{Print pattern width}   \times 100\%}{\text{Spec pattern width}} \leq 30\%$ <p><b>Drawing slant:</b></p> <p>Print pattern length <math>\leq 10\text{mm}</math>, slant angle <math>\leq 3^\circ</math> ;                      10mm &lt; Print pattern length <math>\leq 20\text{mm}</math>, slant angle <math>\leq 1.5^\circ</math></p>  <p><b>Pattern serration:</b> <math>H \leq 0.05 \text{ mm}</math></p> <p><b>Pattern leak print/ error/overprint:</b> not allowed</p> <p><b>Pattern break line:</b> width <math>\leq 0.10 \text{ mm}</math></p> <p><b>Logo pattern color windage / color thin:</b> Follow the limit samples.</p>	Minor

Item	Items to be	Inspection Standard	Classification
------	-------------	---------------------	----------------





No	inspected		of defects
4.2.10 view area/print i ng area of front surface and view area of rear surface	IR hole(A)/ Light sensor hole(B)/ LED hole(C)	 <ol style="list-style-type: none"> <li>1. A.B.C hole must be according the transmittancy</li> <li>2. Light leakage on A.B.C hole or follow the limited sample.</li> <li>3. A.B.C hole (LED) hole only judge by black background, no need to check in the lamb condition.</li> </ol>	Minor
	Surface dirty	<ol style="list-style-type: none"> <li>1. Dirty can not be cleaned follow the dot spec.</li> <li>2. Accept while the dirty can be cleaned.</li> <li>3. The quality guarantee period of protective film is 3months, during the period, the spot or contamination is not allowed.</li> </ol>	
	Printing area Light leakage	Follow the dot defect spec, MAX, Severity - see light leakage limit sample	
	Ink overflow	Visual inspection 30cm not allowed	
	Color discordant	Obvious color difference in the BM area is not allowed	
	Icon scratch of printing logo area	Icon printing logo area is not allow penetrability scratch	





## 7. RELIABILITY

Test Item	Test Condition
High Temperature Operation	50°C for 96 hours
Low Temperature Operation	0°C for 96 hours
High Temperature Storage	60°C for 96 hours
Low Temperature Storage	-10°C for 96 hours
High Temperature Operation Humidity Operation	60°C, 90%RH for 72 hours
Thermal Shock	-10°C(30min) ~+25°C(5min)~ +60°C(30min) for 10 cycles



## 8. HANDLING PRECAUTION

### 8.1 SAFETY

- (1) Do not swallow any liquid crystal, even if there is no proof that liquid crystal is poisonous.
- (2) If the LCD panel breaks, be careful not to get liquid crystal to touch your skin.
- (3) If skin is exposed to liquid crystal, wash the area thoroughly with alcohol or soap.

### 8.2 STORAGE CONDITIONS

- (1) Store the panel or module in a dark place where the temperature is  $23\pm 5^{\circ}\text{C}$  and the humidity is below  $50\pm 20\%\text{RH}$ .
- (2) Store in anti-static electricity container.
- (3) Store in clean environment, free from dust, active gas, and solvent.
- (4) Do not place the module near organics solvents or corrosive gases.
- (5) Do not crush, shake, or jolt the module.

### 8.3 HANDLING PRECAUTIONS

- (1) Avoid static electricity which can damage the CMOS LSI.
- (2) The polarizing plate of the display is very fragile. So, please handle it very carefully.
- (3) Do not give external shock.
- (4) Do not apply excessive force on the surface.
- (5) Do not wipe the polarizing plate with a dry cloth, as it may easily scratch the surface of plate.
- (6) Do not use ketonic solvent & Aromatic solvent, use with a soft cloth soaked with a cleaning naphtha solvent.
- (7) Do not operate it above the absolute maximum rating.
- (8) Do not remove the panel or frame from the module.

### 8.4 WARRANTY

- 1) The period is within twelve months since the date of shipping out under normal using and storage conditions.
- 2) According to Kingtech TFT LCD quality standard, Kingtech will rework or exchange for functional defect goods since within one year.



## 9. Package Drawing

TBD